



Product Description

The S10040180P1 is a Hybrid Push Pull amplifier module. The part employs GaAs die and is operated from 40MHz to 1000MHz. It provides excellent linearity and superior return loss performance with low noise and optimal reliability.

Features

- Excellent Linearity
- Superior Return Loss Performance
- Extremely Low Distortion
- Optimal Reliability
- Extremely Low Noise
- Unconditionally Stable Under All Terminations
- 18.0dB Min. Gain at 1000MHz
- 260mA Max. at 24VDC

Applications

- 40MHz to 1000MHz CATV Amplifier Systems

Optimum Technology Matching® Applied

- GaAs HBT
- GaAs MESFET
- InGaP HBT
- SiGe BiCMOS
- Si BiCMOS
- SiGe HBT
- GaAs pHEMT
- Si CMOS
- Si BJT
- GaN HEMT
- RF MEMS

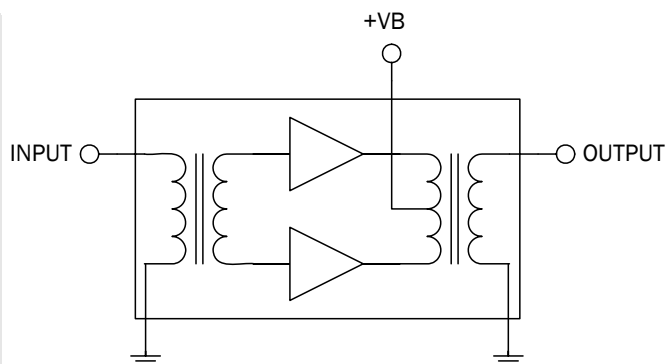

Parameter	Specification			Unit	Condition
	Min.	Typ.	Max.		
Overall					$V_B = 24V; T_{MB} = 30^\circ C; Z_S = Z_L = 75\Omega$
Power Gain		18.0		dB	f=50MHz
	18.0		19.5	dB	f=1000MHz
Slope [1]	0.5		1.5	dB	f=40MHz to 1000MHz
Flatness of Frequency Response			0.8	dB	f=40MHz to 1000MHz (Peak to Valley)
Input Return Loss	20.0			dB	f=40MHz to 160MHz
	18.0			dB	f=160MHz to 870MHz
	15.0			dB	f=870MHz to 1000MHz
Output Return Loss	20.0			dB	f=40MHz to 160MHz
	18.0			dB	f=160MHz to 870MHz
	15.0			dB	f=870MHz to 1000MHz
Noise Figure		3.0	4.0	dB	f=50MHz to 1000MHz
Total Current Consumption (DC)		250.0	260.0	mA	

1. The slope is defined as the difference between the gain at the start frequency and the gain at the stop frequency.

Absolute Maximum Ratings

Parameter	Rating	Unit
RF Input Voltage (single tone)	65	dBmV
DC Supply Over-Voltage (5 minutes)	30	V
Storage Temperature	-40 to +100	°C
Operating Mounting Base Temperature	-30 to +100	°C



Caution! ESD sensitive device.

Exceeding any one or a combination of the Absolute Maximum Rating conditions may cause permanent damage to the device. Extended application of Absolute Maximum Rating conditions to the device may reduce device reliability. Specified typical performance or functional operation of the device under Absolute Maximum Rating conditions is not implied.

RoHS status based on EU Directive 2002/95/EC (at time of this document revision).

The information in this publication is believed to be accurate and reliable. However, no responsibility is assumed by RF Micro Devices, Inc. ("RFMD") for its use, nor for any infringement of patents, or other rights of third parties, resulting from its use. No license is granted by implication or otherwise under any patent or patent rights of RFMD. RFMD reserves the right to change component circuitry, recommended application circuitry and specifications at any time without prior notice.

Parameter	Specification			Unit	Condition
	Min.	Typ.	Max.		
Distortion data 40MHz to 870MHz					$V_B = 24V, T_{MB} = 30^\circ C, Z_S = Z_L = 75\Omega$
CTB		-68	-66	dBc	132 ch flat; $V_O = 40 \text{ dBmV}^{[2]}$
XMOD		-59	-57	dBc	132 ch flat; $V_O = 40 \text{ dBmV}^{[2]}$
CSO		-68	-66	dBc	132 ch flat; $V_O = 40 \text{ dBmV}^{[2]}$

2. 132 channels, NTSC frequency raster: 55.25 MHz to 853.25 MHz, +40 dBmV flat output level.

Composite Second Order (CSO) - The CSO parameter (both sum and difference products) is defined by the NCTA.

Composite Triple Beat (CTB) - The CTB parameter is defined by the NCTA.

Cross Modulation (XMOD) - Cross modulation (XMOD) is measured at baseband (selective voltmeter method), referenced to 100% modulation of the carrier being tested.

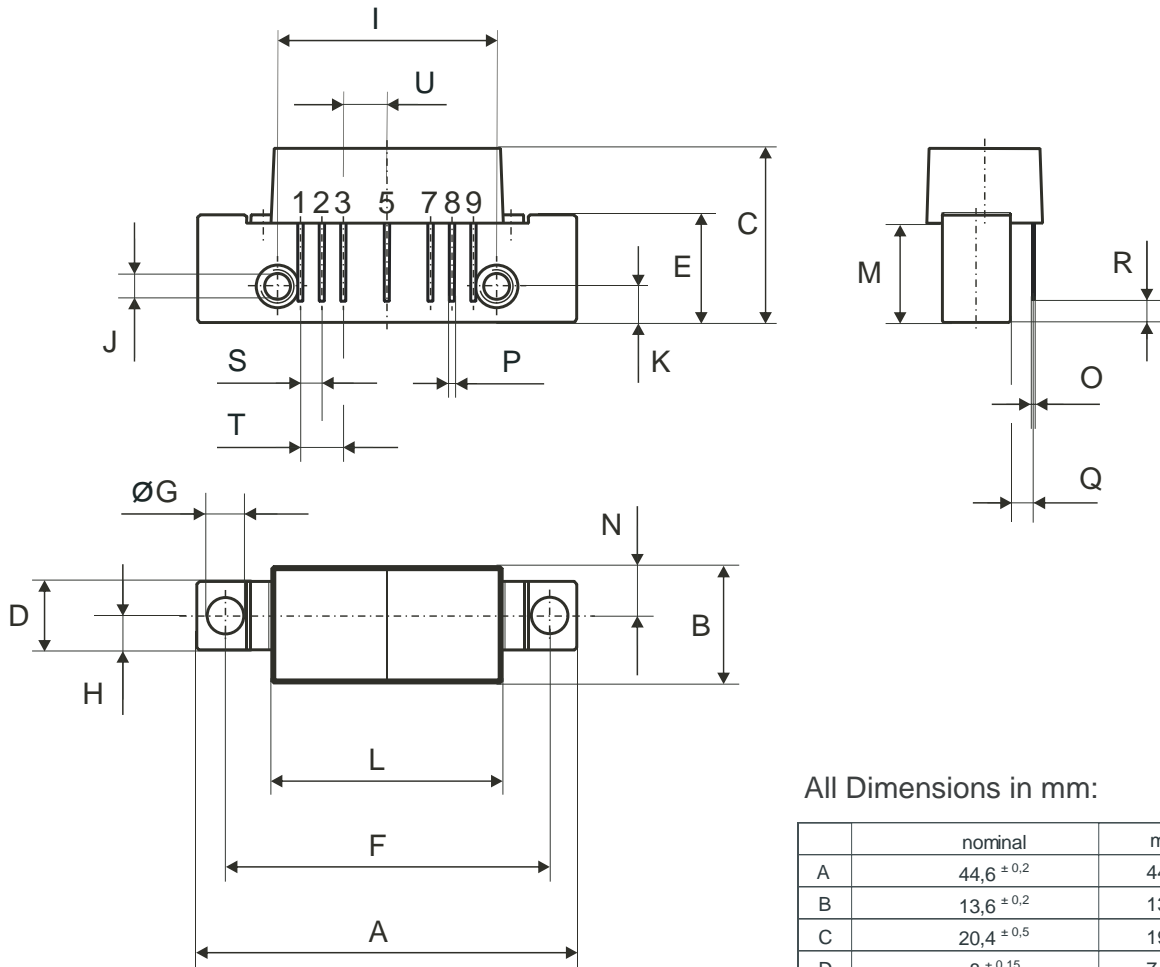

All Dimensions in mm:

	nominal	min	max
A	44,6 ±0,2	44,4	44,8
B	13,6 ±0,2	13,4	13,8
C	20,4 ±0,5	19,9	20,9
D	8 ±0,15	7,85	8,15
E	12,6 ±0,15	12,45	12,75
F	38,1 ±0,2	37,9	38,3
G	4 ^{+0,2 / -0,05}	3,95	4,2
H	4 ±0,2	3,8	4,2
I	25,4 ±0,2	25,2	25,6
J	UNC 6-32	-	-
K	4,2 ±0,2	4,0	4,4
L	27,2 ±0,2	27,0	27,4
M	11,6 ±0,5	11,1	12,1
N	5,8 ±0,4	5,4	6,2
O	0,25 ±0,02	0,23	0,27
P	0,45 ±0,03	0,42	0,48
Q	2,54 ±0,3	2,24	2,84
R	2,54 ±0,5	2,04	3,04
S	2,54 ±0,25	2,29	2,79
T	5,08 ±0,25	4,83	5,33
U	5,08 ±0,25	4,83	5,33

Pinning:

	1	2	3	4	5	6	7	8	9
INPUT									
GND									
GND									
+VB									
GND									
GND									
OUTPUT									

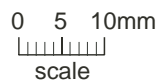

Notes:

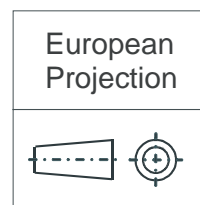

S10040180P1

